

Datasheet

Surge protection for power supply systems

SPD type 3 for AC power supplies / EnerPro D

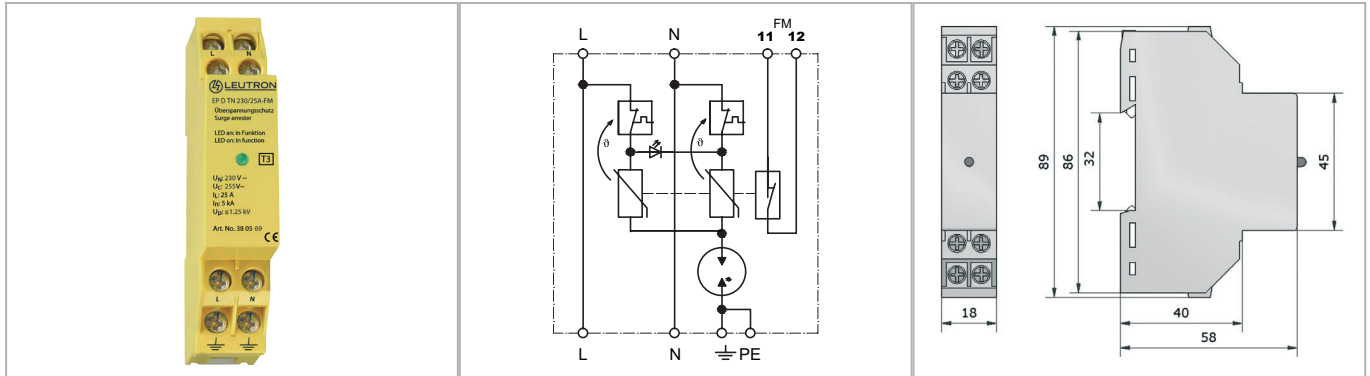

Compact 2-pole surge arrester for rated voltages of 230 V and rated load current of 25 Ampere.

- With remote signalling contact (FM)
- Practical compact housing with minimum space requirement
- Line function and equipment control by LED/Monitoring of conductor and arrester via LED

Technical Data		EP D TN 230V/25A-FM
Nominal alternating voltage (50/60Hz)	UN	230 V~
Max. continuous operating voltage AC (50/60Hz)	Uc	255 V~
Rated load current	IL	25 A
Protection level L-N	Up	≤ 1,0 kV
Protection level L/N-PE	Up	≤ 1,5 kV
Combined surge	Uoc	4 kV
Response time L-N/L,N-PE		≤ 25/≤ 100 ns
Nominal impulse discharge current (10 x 8/20μs)	In	5 kA
Max. impulse discharge current (8/20μs)	I _{max}	8 kA
Max. allowed fuse or back-up fuse		25 A gL/gG
Operating temperature range	TU	-40 - +80 °C
Min. conductor cross section at terminals		2.5 mm ² single-wire / 1.5 mm ² flexible with sleeve
Max. conductor cross section		2.5 mm ² flexible / 4 mm ² solid
Enclosure material / colour		polycarbonate (halogen-free) UL 94-V0 / yellow
Degree of protection (IEC EN 60529)		IP 20
Mounting on		35 mm DIN rail (EN 60715)
FM contact / contact type		break contact
Switching capacity		250 V/2 A
Max. cross section of the remote signalling line		1.5 mm ² solid/flexible

Order Data

Product	EP D TN 230V/25A-FM
Article-No.	38 05 69